

PORTA A SOFFIETTO

ISTRUZIONI DI MONTAGGIO

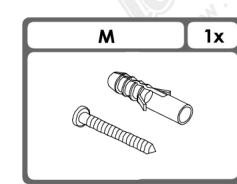
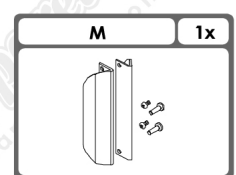
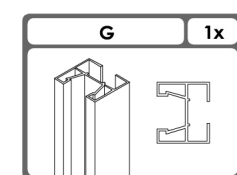
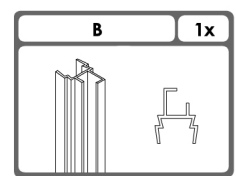
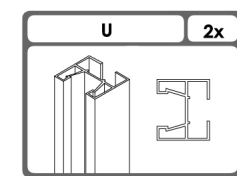
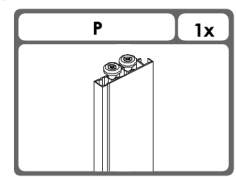
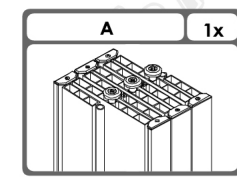
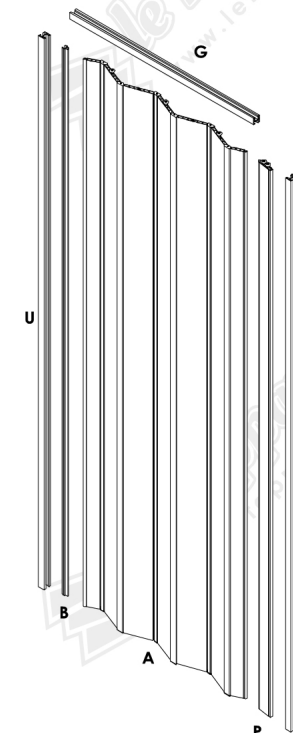
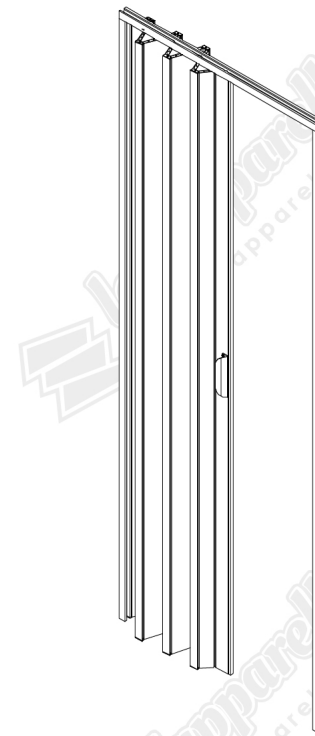

1 Agganciare il profilo partamaniglia (P) all'anta a soffietto (A).

This diagram shows three circular callouts. The first shows the handle profile (P) being aligned with the pleated door (A). The second shows the profile being pushed onto the door. The third shows the profile fully attached to the door.

2 Posizionare la guida superiore (G) sull'architrave, segnare i fori per il fissaggio quindi forare ed inserire i tasselli "T".

This diagram shows a hand marking the lintel with a pencil. A circular callout shows a hand using a 6mm drill bit to drill a hole. Another callout shows a hand inserting a plastic anchor (T) into the hole.

3 Posizionare la guida superiore "G" sull'architrave e fissarla con una sola vite, esclusivamente nella parte centrale, quindi ruotarla in modo perpendicolare al vano.

This diagram shows the upper guide (G) being placed on the lintel. A circular callout shows a hand using a screwdriver to tighten a screw (V) into the center of the guide.

4 Agganciare l'anta alla guida superiore, inserendo i supporti presenti sulla parte alta dell'anta all'interno della guida. Inserire l'anta con il profilo maniglia rivolto verso il lato in cui si vuole l'apertura della porta.

This diagram shows the door (A) being lowered into the upper guide (G). A circular callout shows the door's top edge being inserted into the guide's channel.

5 Posizionare l'anta raggruppata al centro della guida superiore, quindi ruotare la guida e fissarla con le viti in dotazione nei fori fatti in precedenza.

This diagram shows the door (A) centered in the upper guide (G). A circular callout shows a hand using a screwdriver to tighten a screw (V) into the guide.

6 Poggiare i due profili laterali (U) alle pareti, metterli a piombo, quindi fissarli con i tasselli in dotazione. Il profilo laterale, che presenta un gancio o una piastrina in metallo nella parte centrale, va posizionato come battuta dell'anta.

This diagram shows two side profiles (U) being placed against the walls. A circular callout shows a hand using a spirit level to check if the profile is vertical. Another callout shows a hand using a 2mm drill bit to drill a hole. A final callout shows a hand inserting a screw (T) into the hole.

7 Inserire ad incastro il profilo attacco anta (B) nel profilo laterale (U) sul lato opposto all'apertura. Iniziando dalla parte superiore, esercitare la pressione necessaria a sentire lo scatto d'inserimento, procedere quindi per l'intera lunghezza del profilo. Completata questa operazione inserire ad incastro anche l'ultimo pannello dell'anta all'interno del profilo attacco anta.

This diagram shows the door attachment profile (B) being inserted into the side profile (U). A circular callout shows the profile being pushed into the side profile. Another callout shows the door (A) being inserted into the attachment profile (B). A small diagram at the bottom shows the assembly of the side profile (U), attachment profile (B), and door (A).

8 Completare l'installazione inserendo la maniglia.

This diagram shows a hand using a screwdriver to tighten a screw into the handle (M) which is being inserted into the door (A).